

**Utilisation - Use**

Poids destinés à la vérification ou l'étalonnage des poids de classe F2 et pour utilisation avec des instruments de pesage de classe I (précision spéciale) et de classe II (précision fine).

Weights intended for use in the verification or calibration of class F2 weights and for use with weighing instruments of special accuracy class I and high accuracy class II.

**Description - Description**

**Référentiel - Conformité : Recommandation OIML R111**

Conformity : OIML R111 Recommendation

**Caractéristiques Acier inoxydable :**

Stainless steel specifications :

**Masse volumique : 8000 ±100 kg/m<sup>3</sup>**  
Density



**Rugosité : Rz(µm) < 2 - Ra(µm) < 0,4**  
Roughness

**Susceptibilité magnétique :**  
Magnetic susceptibility

m < 1 g                   χ < 10  
2 g < m < 10 g       χ < 0,7  
m > 20 g               χ < 0,2

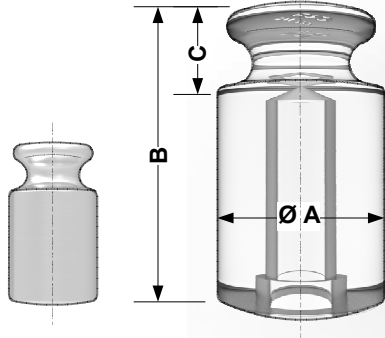
**Magnétisation permanente : < 25 µT**  
Permanent magnetisation







Identification Identification	En option Option
	 <b>ACCREDITATION</b> N° 2.1218 MASSE  <b>Etalonnage</b> Calibration

Nos accessoires - Accessories	
 <b>Préhension</b> Handling system	 <b>660 0000</b> Gants coton Cotton gloves
 <b>Coffret bois</b> Wooden box	 <b>Valise plastique</b> Plastic case

**Caractéristiques techniques - Technical specifications**

Poids avec cavité d'ajustage (sauf 1 à 20 g monobloc),  
Identification pour assurer la traçabilité.

Weights with adjustment cavity (except 1 to 20g monobloc)  
- Identification for the traceability

Valeur nominale Nominale value	1 g	2 g	5 g	10 g	20 g	50 g	100 g	200 g	500 g	1 kg	2 kg	5 kg	10 kg	20 kg
<b>Référence</b> Reference	101 4414	102 4414	103 4414	104 4414	105 4414	106 4414	107 4414	108 4414	109 4414	201 4414	202 4414	203 4414	204 4414	205 4414
Ø A	6,0	6,0	8,0	10,0	13,0	18,0	22,0	28,0	38,0	48,0	60,0	80,0	100,0	140,0
B	6,0	10,4	14,4	18,0	21,6	30,8	40,5	51,3	66,2	83,0	104,0	144,5	183,5	193,5
C	2,8	2,8	3,9	4,6	5,6	8,0	11,0	12,5	17,0	22,0	28,0	37,0	47,0	64,0
<b>EMT ± δm en µg</b> MPE ± δm in µg	0,03	0,04	0,05	0,06	0,08	0,10	0,16	0,3	0,8	1,6	3,0	8,0	16	30
<b>Système de préhension</b> Handling system	666 0000 (100 mm) 					692 0000 (220 mm) 					669 0000	664 0000	665 0000	
	670 0000 (150 mm) 								693 0000	695 0000	694 0000			

EMT : Erreurs Maximales Tolérées - MPE : Maximum Permissible Errors

Dimensions en mm - Dimensions in mm

ZWIEBEL SAS - SAINT JEAN SAVERNE - BP 50002 - F-67701 SAVERNE CEDEX

Tél. - Tel. : +33 (0)3.88.71.53.10 - Fax: +33 (0)3.88.71.20.92

E-mail : commercial@zwibel.fr - www.zwibel.fr